



saunum

Saunum Air

heater with a sauna room indoor heat equalizer

Almost Heaven Group LLC
<https://www.almostheaven.net>
(304) 645-2310



THE BEST SAUNA EXPERIENCE



I am very glad that you have invested in the Saunum device, and I believe that our innovative technology will offer you a wonderful and extraordinary sauna experience.

I have a degree in thermal engineering and come from the Southern Estonia, where my love for saunas began. The special feature of local historic smoke saunas is the lower temperature and higher humidity level than, for example, a classic Finnish sauna. In ordinary saunas, the stone volume of the sauna heater is generally small. Such an arrangement can cause a sudden, burning hot steam and an extremely uneven temperature, where your head and shoulder level is really hot, but your feet are left cold. Such an experience can be quite unpleasant and may cause headaches and lead to body stress. However, in ancient smoke saunas and Native American saunas, the stones were first heated during the day. Then the heat stored in the stones was used to cleanse the body and create a truly enjoyable sauna experience.

Inspired by the experience of a smoke sauna, I wanted to create an innovative solution that combines the best features of an authentic sauna with modern technology; enabling a pleasantly mild and relaxing sauna experience without painfully scorching steam. For that, however, I had to solve the problem of how to achieve an even temperature, at both the head and foot levels. My development work was supported by research done alongside Tallinn University of Technology in



which we analyzed the thermal stratification and air movement in the sauna room. Saunum was born in cooperation between scientific thinking and technological innovation.

Saunum's unique patented mixing system of air layers captures the hot steam that rises under the ceiling of the sauna room, mixes it with the cooler air from the surface of the floor, and directs the milder steam back evenly. This makes for an enjoyable, unaggressive heat. You can sit in the sauna for a longer time, and enjoy a sweat and a deep cleanse without feeling tired. The stone volume of our heaters is significantly larger than other sauna heaters, which is the reason for the especially pleasant indoor climate with long and soft steam.

A moist steamy sauna, a sanarium, a therapeutic salt sauna, or a healthy aroma sauna – all of these functions are available on Saunum's devices to create a truly relaxing sauna experience. When using Himalayan salt orbs in our device, salt ions that are beneficial to skin and respiratory tract evaporate and the steam circulates these into the air. Adding a sauna aroma system that blends steam and healthy aroma oil creates an even more enjoyable sauna environment.

Saunum's sauna devices are suitable for both adults and children.

Have a pleasant sauna!

Andrus Vare
The creator of Saunum



saunum

Saunum

congratulates you

on choosing a heater with
an innovative sauna room
indoor Heat Equalizer!



CONTENTS

Safety information _____	6
DIRECTION FOR USE	
Heating the sauna room _____	10
Using the sauna climate device _____	10
Adjusting the temperature _____	11
Regulation of the sauna _____	11
Use of Himalayan salt _____	11
Ladling water on the heater _____	12
Loading the stones _____	12
Warnings _____	13
Solving problems _____	14
Maintenance _____	16
Sauna room _____	17
Sauna room ventilation _____	17
Sizing your sauna _____	18
INSTALLING	
Before the installation _____	20
Dimensions _____	21
Product completeness _____	23
Parts of the device _____	24
Installation instructions _____	25
Electrical connection _____	29
Electric heater insulation resistance _____	35
Installing and replacing the heating elements _____	35
Warranty _____	36
Installation Report _____	38



These instructions for installation and use are intended for the sauna owner or maintenance provider, as well as the electrician responsible for installing the Saunum Air heater with a sauna room indoor climate device. After installing the heater with an indoor climate device, the instructions must be handed over to the owner or maintenance provider.

Before using the **Saunum Air** heater with an indoor heat equalizer, read the installation and safety instructions.

The Saunum Air is intended for heating the sauna room at 140–194 °F and for levelling the sauna room climate during steaming.

Please note! The heat equalizing module and the heater of the sauna must not be operated in temperatures exceeding 194 °F!



Do not use the Saunum Air for any other purposes!



To connect the Saunum Air to the power network, a control device for the control of electric heaters is required. The control device must correspond to the power of the heater used according to Table 1 on page 8.

Saunum Air is intended for use with Saunum AirIQ only. Use of any other control type will void both warranty and UL listing.

NOTE: To ensure the longevity of the device, make sure that the temperature of the sauna room at the height of the lower part of the device does not exceed 176 °F. If it is exceeded, the thermal protection will be applied and the fan will stop; the fan will start running again if the temperature drops below the fuse limit of application.

The manufacturer is not responsible for any malfunction caused by an overrun of the authorized operating temperature.

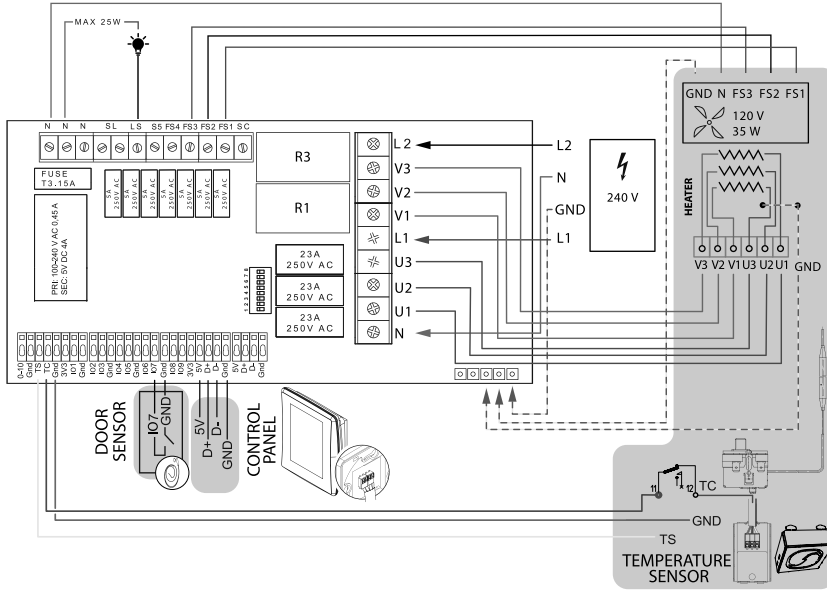

SAFETY INFORMATION

IMPORTANT!

All wiring must be done in accordance with National Electric Code and local building code.

All supply wire to be 90°C copper.



Table 1

DEVICE	WATTAGE	VOLTAGE	PHASE	AMPERAGE	CIRCUIT BREAKER
Saunum Air – 5	4800	240	1	20	30 A
Saunum Air – 7	6400	240	1	26.67	40 A
Saunum Air – 10	9600	240	1	40	50 A

DEVICE	ROOM SIZE CUBIC FEET	MIN. CEILING HEIGHT	MINIMUM SAFE DISTANCE FROM PROTECTIVE GRILLE TO CEILING
Saunum Air – 5 (stainless steel cage body)	106–212	71.48 in.	39.37 in.
Saunum Air – 7 (stainless steel cage body)	212–282	71.48 in.	39.37 in.
Saunum Air – 10 (stainless steel cage body)	282–424*	80.54 in.	39.37 in.
Saunum Air – 5 (solid steel body)	106–177	71.95 in.	39.37 in.
Saunum Air – 7 (solid steel body)	177–247	71.95 in.	39.37 in.
Saunum Air – 10 (solid steel body)	247–353	88.90 in.	47.24 in.

* only for home use up to 500 adjusted cubic feet



Wires from Electrical Panel to Power Unit	Wires from Power Unit to Heater (Element Circuits)	Wires from Power Unit to Heater (Fan Circuit)
(2) #10 + N + G	(6) #14 + G	(3) #18 + N + G
(2) #8 + N + G	(6) #14 + G	(3) #18 + N + G
(2) #6 + N + G	(6) #14 + G	(3) #18 + N + G

MINIMUM SAFE DISTANCE FROM THE HEATER
(See diagrams on page 19)

MINIMUM SAFE DISTANCE FROM FAN OUTPUT

A: 6" from sides & B: 6" from the front side	20 in.
A: 6" from sides & B: 6" from the front side	20 in.
A: 8" from sides & B: 10" from the front side	20 in.
A: 2" from sides & B: 2" from the front side	20 in.
A: 2" from sides & B: 2" from the front side	20 in.
A: 2" from sides & B: 2" from the front side	20 in.



HEATING

THE SAUNA ROOM

Before using the Saunum Air for the first time, make sure that:

- the electrical connections meet the requirements
- the supply voltage corresponds to the nominal ratings allowed for the Saunum Air
- the grounding (GND) is in working order
- the attachments of the sauna climate device housing are in order
- the Saunum Air is properly attached to the wall
- the over-current fuses are in working order the fan rotor rotates smoothly
- there are no tools or materials left after mounting the device in the housing.

When switching the Saunum Air on, check:

- the direction of the air flow – the air intake from the upper and the output from the lower opening
- that there is no vibration or excessive noise when the fan is running.

When the Saunum Air is switched on for the first time, the heating elements and the stones will emit an odor. The sauna room must be properly ventilated to remove the anticipated initial smell.

Presuming proper insulation of the room and that the power of the heater is suitable for the sauna size, it takes 45–90 minutes to reach the desired temperature.

The stones are usually heated to proper temperature for water usage at the same time as the sauna room. Turn the Saunum Air fan on just before entering the sauna room; this will help prevent the sauna bench from overheating and using excessive energy.

Saunum's recommended temperature for sauna operation is 149 °F to 176 °F.

USING THE SAUNA CLIMATE DEVICE



Before switching the Saunum Air on, always make sure that nothing is above or near it.

The operating time of the sauna climate device model Sauna Air may be adjusted by a separate control device.

- Do not connect the device directly to the utilities and/or power!
- The Saunum Air must not be used if the components of its housing have been removed and/or the wiring diagram has been changed.
- Children should not be allowed to access or play with the Saunum Air.



- When switching the Saunum Air on and off, refer to the instructions for use of the control device you are using.



After using the sauna, make sure that all parts of the Saunum Air are switched off (the heating and the fan have stopped).

ADJUSTING THE TEMPERATURE



It is recommended to keep the air circulation fan of the Saunum Air switched off during the heating of the sauna room!

This will allow the sauna room to heat up faster and the bench will not get too hot during the warming process. To find the right setting, start testing at the lowest temperature and lowest airflow rate. If the temperature becomes too high while in the sauna room, reduce the maximum temperature in the sauna room or lower the fan speed of the Saunum Air.

REGULATION OF THE SAUNA

The amount of air circulation generated by the device is regulated by the AirIQ touch pad, which allows for control of air speeds

to your preferred comfort level. To regulate the air temperature in the sauna room, there is a steam air cooling damper on the left side of the heater housing, lower than the device stone area (see page 23). The recommended setting is to keep the cooling damper 1/3 open. To cool the steam, try to open the damper little by little.

USE OF HIMALAYAN SALT

The Saunum Air comes with Himalayan salt. The use of salt orbs in the device is optional and does not affect the main function of the device if not elected.

To use the salt, they must be installed in the sockets between the air outlet grille and the fan. Make sure that the salt nested correctly in each individual slot and do not impede the fan rotation.

To install or remove the salt, remove the air output grille (see page 27) and place the salt in their sockets. After installing or removing the salt, reposition the air output grille. The Saunum Air may only be used with the air output grille in place!

Do not use/start the device if the salt become dislodged near the fan housing!



The use of third-party salt is not covered by the device warranty.



LADLING WATER ON THE HEATER

The air in the sauna becomes dry as it heats up. Therefore, it is necessary to create steam to achieve a suitable level of humidity. The effects of heat and steam on people are different. When testing the different settings of the Saunum Air, you will find the most suitable combination of temperature and humidity. The effects of heat and steam on people are different. When testing the different settings of the SAUNUM heat equalizer, you will find the most suitable combination of temperature and humidity.

The volume of the sauna ladle should not exceed 6.4 fluid oz. When throwing water, the amount of water should not exceed 6.4 fluid oz, because by pouring too much water on the stones at once, some of it may be sprayed outwards in splashes of boiling water.

Make sure that people are at a safe distance from the heater when creating steam! Hot steam and water splashes cause skin burns.

The water to be ladled or tossed lightly onto the heater must meet the requirements for clean domestic water. Only fragrances specially designed for sauna may be used in the water. Follow the instructions on the package.

LOADING THE STONES

Stacking stones has a great effect on the operation of the heater.

Important to know:

- The diameter of the stones must be 2–4 inches.
- Use Saunum stones.
- Do not use light, porous ceramic “stones”, or soft tiles in the heater. They do not store enough heat when heated and can result in damage to the heating elements.
- Wash any dust off the stones and dry them before placing them in the heater.



When using Saunum equipment, we always recommend doing so with high-quality polished sauna stones!

When loading the stones, note the following:

- Do not allow the stones to fall into the heater.
- Do not force the stones between the heating elements.
- Do not allow the stones to rest on the heating elements with their own weight, but load the stones so that they support each other.
- Do not stack the stones on the heater.
- Do not place objects in the vicinity of the stone area or the fan of the sauna climate device that may change the amount or direction of the air flowing through the Saunum Air.



WARNINGS

Staying in the sauna room for a long time raises your body temperature, which may be dangerous to your health!

- Do not touch the hot heater – the stones and the outside of the heater may burn you!
- Do not allow children, disabled or sick people into the sauna room without supervision!
- Consult a doctor about medical concerns related to steam, heat, and/or salt treatment!
- Make sure you are not allergic to salt treatment. Saunum is not responsible for potential side effects of salt treatment in the sauna room!
- Consult a pediatrician or doctor about use of the sauna by children!
- Be careful when moving in the sauna and sauna room, as the bench and the floor may be slippery!
- Do not go to the sauna under the influence of alcohol, drugs, or narcotics!
- Do not sleep in the hot sauna room!
- Sea air and humid climates may cause an oxide layer (rust) on the metal surfaces of the heater!
- A guardrail or fence is required around the heater to prevent burns from accidental contact.
- Make sure you have proper ventilation in the sauna room. Saunum is not responsible for possible salt corrosion of equipment and machinery.
- Do not hang towels and clothes to dry in the sauna room – this may cause a fire hazard!
- Excessive moisture may damage the electrical equipment!
- Clear obstructions closer than 20" in front of the fan opening!
- Sauna users must not keep their feet or other body parts closer than 20 in. in front of the fan!

Please note. The electric heater requires a control panel and stones.



Do not leave the fan of the heat equalizing module running when you are not in the sauna room – this will cause an excessive energy consumption, and the sauna bench will become too hot!



Contact a qualified sauna service specialist to perform maintenance. In the case of any disturbances in the operation of the Saunum Air, stop use of the device immediately and have the device inspected by a person authorized by Saunum.

THE SAUNUM AIR IS NOT HEATING OR BLOW AIR. ENSURE THE FOLLOWING:

- That the heater breakers and fuses are in working order.
- That all wiring is properly connected.
- That the Saunum Air is switched on.
- The maximum temperature in the sauna room is to your liking.

THE SAUNA ROOM HEATS UP TOO SLOWLY. THE WATER LADLED OVER THE STONES COOLS THEM DOWN QUICKLY.

- Make sure that the air circulation-fan of the heat equalizing module is switched off during sauna room heating.
- Make sure that the breakers and fuses of the Saunum Air are in working order.
- Make sure that all heating elements have reached a hot temperature when the heat equalizing module is in use.
- Increase the selected temperature on the display panel.

- Make sure that the power output (KW) of the heater is sufficient.
- Check the stones. Stones that are placed too tightly, falling down/sinking closer over time, or the wrong type of stone may interfere with the air flow through the heater and therefore reduce the heating speed.
- Make sure that the ventilation of the sauna room is correct.

THE SAUNA ROOM HEATS UP QUICKLY, BUT THE TEMPERATURE OF THE STONES IS INSUFFICIENT. THE WATER THROWN ON THE STONES FLOWS DOWN.

- Make sure that the power output (KW) of the heater is not too high. If the power of the heater is suitable for the sauna room, it takes 45–90 minutes to reach the desired temperature in a properly insulated sauna room.
- Make sure that the ventilation of the sauna room is correct.
- Reduce the speed of the heat equalizing module.

THE WALL COVERING OR OTHER MATERIAL NEAR THE HEATER BECOMES DIRTY QUICKLY.

- Observe the safety distance requirements.



- Make sure that no heating elements are visible between the stones. If the heating elements are visible, turn off the device, let the stones cool, and lift them so that the heating elements are completely covered.



Stones placed too sparsely may cause the heating elements to overheat and make the indoor climate of the sauna room uncomfortable and may cause a fire hazard!

THE WOODEN SURFACES OF THE SAUNA ROOM BECOME DIRTY OVER TIME.

This process may be accelerated by:

- direct or indirect sunlight
- warmth produced by the heater
- wall protectors (protection equipment has poor heat resistance)
- fine particles from the stones.

THE HEATER SMELLS.

- See section HEATING THE SAUNA ROOM page 10.
- A hot heater may amplify odours mixed with air, but this, however, is not caused by the sauna nor the heater. Causes include paint, glue, oil, spices, etc.

THE SAUNUM AIR IS MAKING NOISE.

- There is always a certain noise when the fan is running. If it is not uniform and/or accompanied by a metallic sound, the fan is likely to need maintenance or repair. Check that there are no foreign objects in the fan air vents.
- Try switching the fan to a lower speed.
- Loud sounds are likely to be caused by stones cracking due to heat.
- Thermal expansion of the heater parts may cause noise when the heater warms up.



MAINTENANCE

Due to large temperature fluctuations, stones tend to break down. Stones must be restacked at least once a year and even more frequently when using the sauna often. When restacking the stones, remove stone fragments from the bottom of the heater and replace the broken stones with new ones. By monitoring this, the heating capacity of the heater remains optimal and the risk of overheating is avoided.

If you use Himalayan salt with the Saunum Air, it is recommended to inspect the salt once a year and, if necessary, replace worn and broken salt with new ones. Make sure that there are no foreign objects in the fan air vents of the heat equalizing module.



CAUTION! Before maintaining and cleaning the Saunum Air, the device power supply must be disconnected from the power and/or utilities, and the moving parts of the unit must completely stop.

Before servicing and cleaning the Saunum Air, make sure that:

- the Saunum Air is disconnected from the power and/or utilities (in addition to the device's power switch, also by means of over-current breakers or fuses);
- the device fan has stopped completely;

- the prescribed occupational safety and personal protective equipment is used when performing the work;
- the connection cables are undamaged. In the event of damage to the connection cables, have the cables replaced by a qualified electrician in accordance with the applicable standards and requirements before continuing maintenance and cleaning work.

The device housing can be cleaned with a cloth dampened with water. Do not use pressure washers, running water, chemical cleaners, or solvents to clean the housing!

Use a 10% citric acid solution to remove scale and rinse with water.

Excessive dirt can prevent the fan from operating correctly, causing an increase in noise when operating. Noise may also increase due to damage/bending of the fan blades. Make sure that there are no foreign objects or salt in the working area of the fan rotor.

The fan will naturally stay free of debris with regular use. If cleaning is needed, we recommend contacting a sauna airflow specialist.



CAUTION! Using compressed air to clean the fan can permanently damage the fan rotor! The fan bearings are maintenance-free and must be replaced if problems occur.



It is recommended to check all electrical connections of the Saunum Air at least once a year. This can be done by a certified electrician.

SAUNA ROOM

A prerequisite for the installation of the Saunum Air is a properly prepared sauna room. The thermal insulation of walls and ceilings must be appropriate, otherwise it will take too much time and energy to heat the room. The power supply cables for the heater and the fan must be indicated on the electrical connection board accordance with Table 1 (see pages 8–9).

SAUNA ROOM VENTILATION

The air in the sauna room must be changed at least six times an hour.



Air intake ventilation in a sauna room is mandatory.

Install the air intake vent under or next to the heat equalizing module. The air intake pipe must have a diameter of 3–1/4"–4".



Air output ventilation in the sauna room is mandatory.

Install the air output vent near the floor, as far as possible from the Saunum Air. The diameter of the air output pipe must be twice the diameter of the intake pipe.

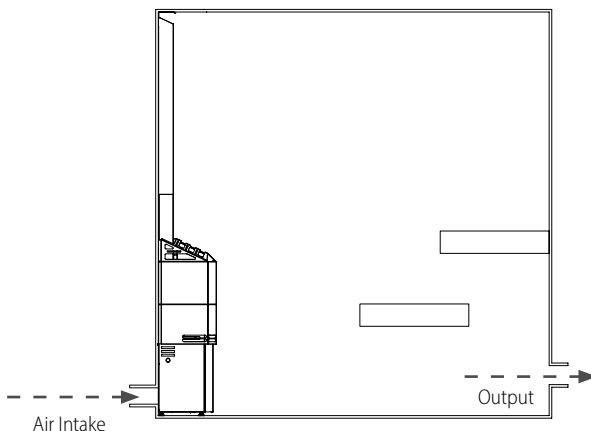



SIZING

YOUR SAUNA

The volume and structures of the sauna affect the selection of heater power. The power requirement increases if there are glass surfaces or other cold surfaces such as tile, brick, concrete, or stone walls in the sauna.

In case there are any glass, tile, brick, concrete, or stone walls in the sauna room (excluding sauna room door), an additional volume of 3.9 cubic foot for each square foot of these wall surfaces should be added to the sauna room size calculation.

To calculate it yourself, multiply the height by the width and the length in feet to get the cubic volume of your sauna room. Then calculate the square footage sum of brick, tile, glass, or concrete surfaces. Multiply the sum of this square footage by 3.90 and add it to your room's cubic volume. As a result, you will have your sauna room volume based on which you can choose the suitable sauna heater output. If the result falls between two different output values, we recommend choosing the larger heater.



Safety distances of the Air Sauna with recommended location in sauna room.

Saunum Air with black solid steel stone basket - 2" A & B dimensions.

Saunum Air with stainless steel stone basket - 6" A & B dimensions.

Note that the device can be placed against sauna room cladding or panels, depending on preference.

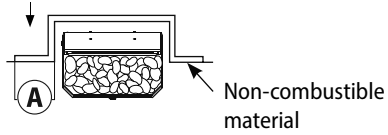

Must follow heater side spacing for non-combustible material.

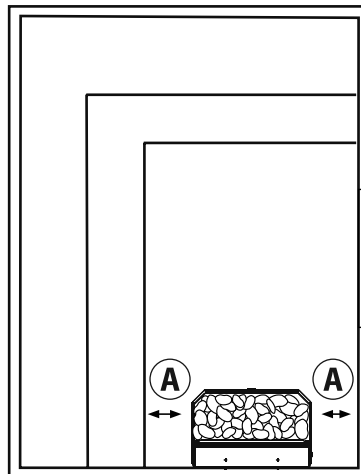
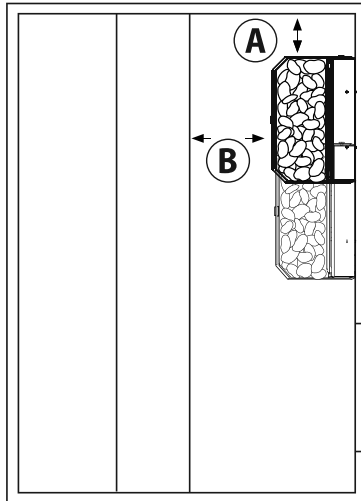
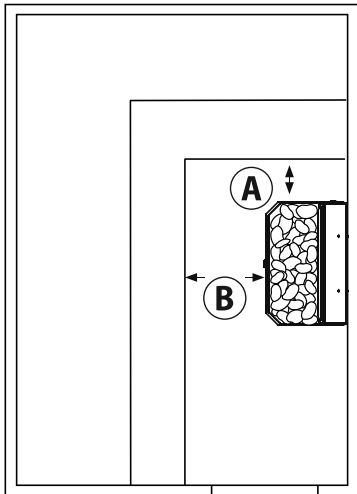

DIRECTION FOR USE



BEFORE THE INSTALLATION

The installation of the Saunum Air must be performed by a qualified electrician. The connection of the device must be performed in a stable location with a cable that meets the temperature conditions. Protective grounding (GND) must be connected to the connection terminal of the device, with the cross-sectional area of the cable being at least 14 AWG, 90°C/194°F. The device must be powered from the control device's supply circuit, which is protected by over-current fuses. The required over-current fuses sizes and the connection cables dimensions are given in Table 1 (see pages 8–9).

All the certified sauna control devices with the operating capacity corresponding to the capacity of the Saunum Air model used in accordance with Table 1 (see pages 8–9) may be used to control the sauna climate control device.

Before starting the installation work, read the installation instructions and observe the following:

- The power and type of the heater are suitable for the given sauna room. The recommended sauna room volume is given in Table 1 (see pages 8–9).
- The supply voltage is suitable for the Saunum Air.
- At the installation site of the sauna climate device, the minimum safety distances given in Table 1 (see pages 8–9), measured from the heater housing, are guaranteed.
- The dimensions of the device are shown in Figures 1 and 2 (see pages 21, 22).
- It must also be ensured that the upper edge of the air output of the is lower than the lower edge of the bench.
- There must be no obstructions in front of the air output from the air flow must be able to flow freely across the sauna room.
- The device works most efficiently when its hot air intake cap is installed against the ceiling of the sauna room and the air is blown under the bench.
- Safety distances must be complied with unconditionally, as failure to do so may result in a fire hazard. Only one sauna device may be installed in the sauna room.



Saunum Air-5/Air7
(Stainless steel body)

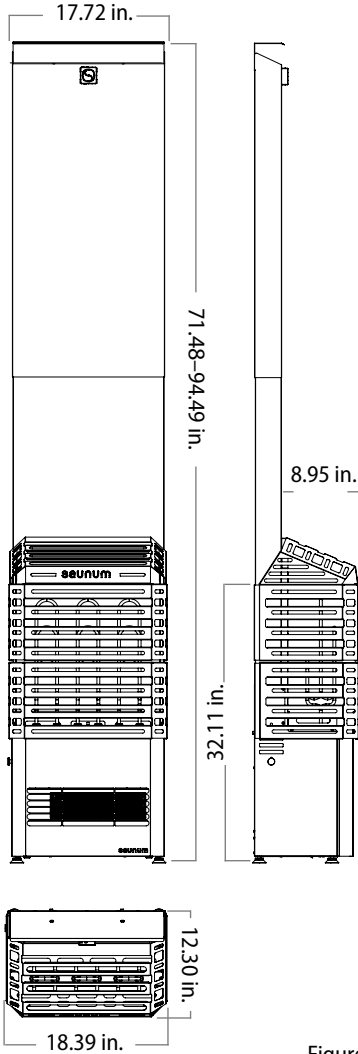

Figure 1

Saunum Air-10
(Stainless steel body)

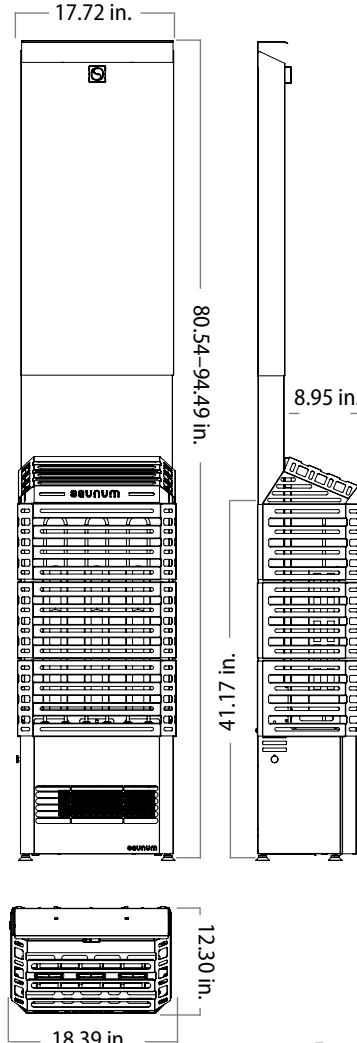

Figure 2

DIMENSIONS

DIMENSIONS



Saunum Air-5/Air-7
(Solid steel body)

Saunum Air-10
(Solid steel body)

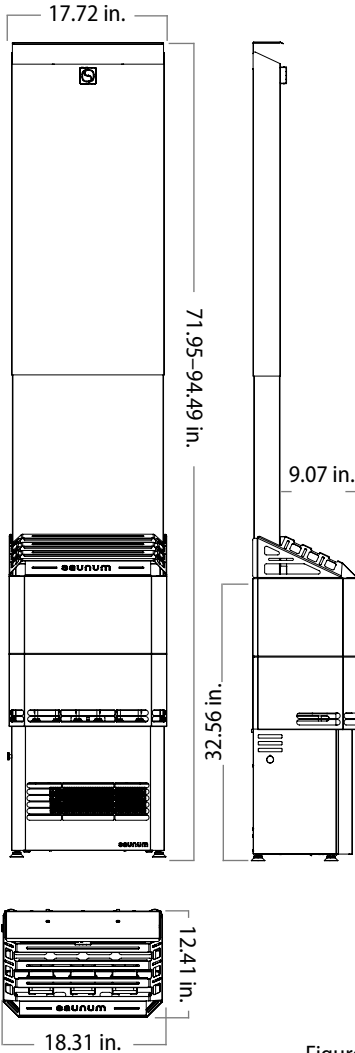

Figure 1

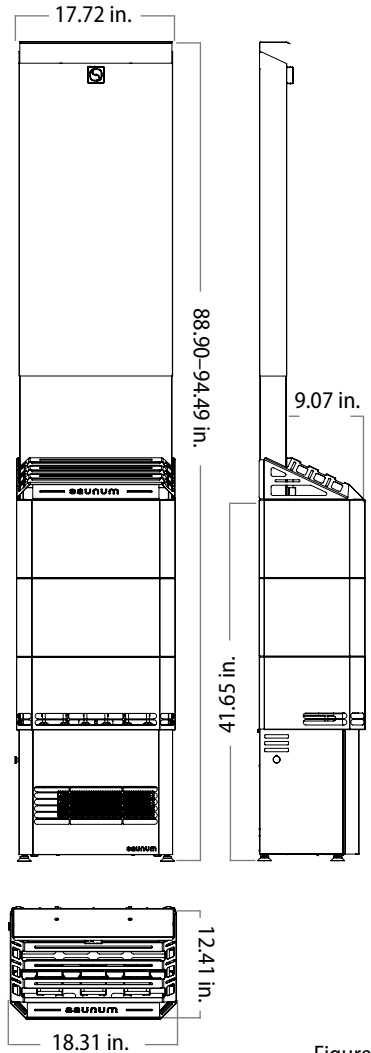
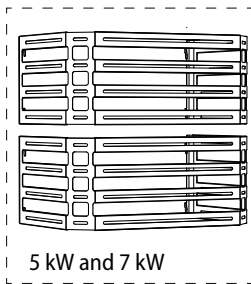
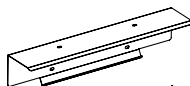
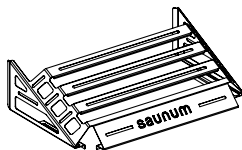
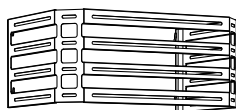

Figure 2



PRODUCT COMPLETENESS

10 kW



5 kW and 7 kW

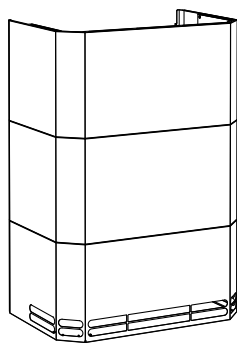
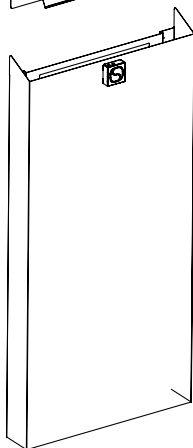
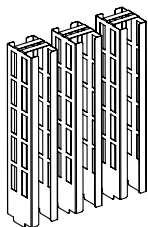
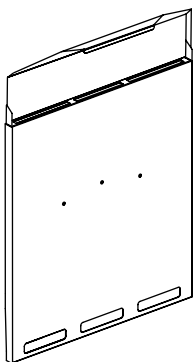

Solid steel body

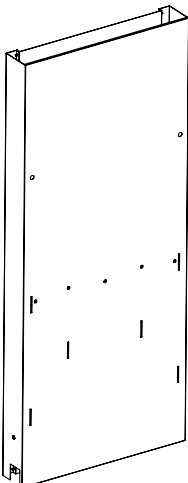
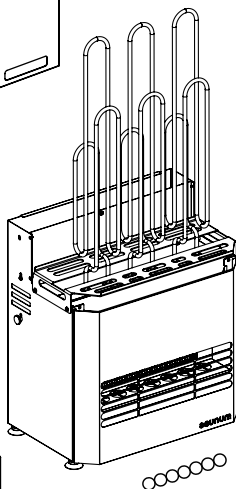
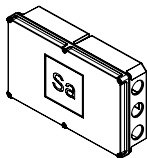
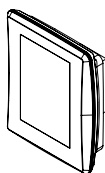

Components necessary for operation that are not part of the Saunum Air composition: power supply cables, and stones.

PRODUCT COMPLETENESS

PARTS OF THE DEVICE

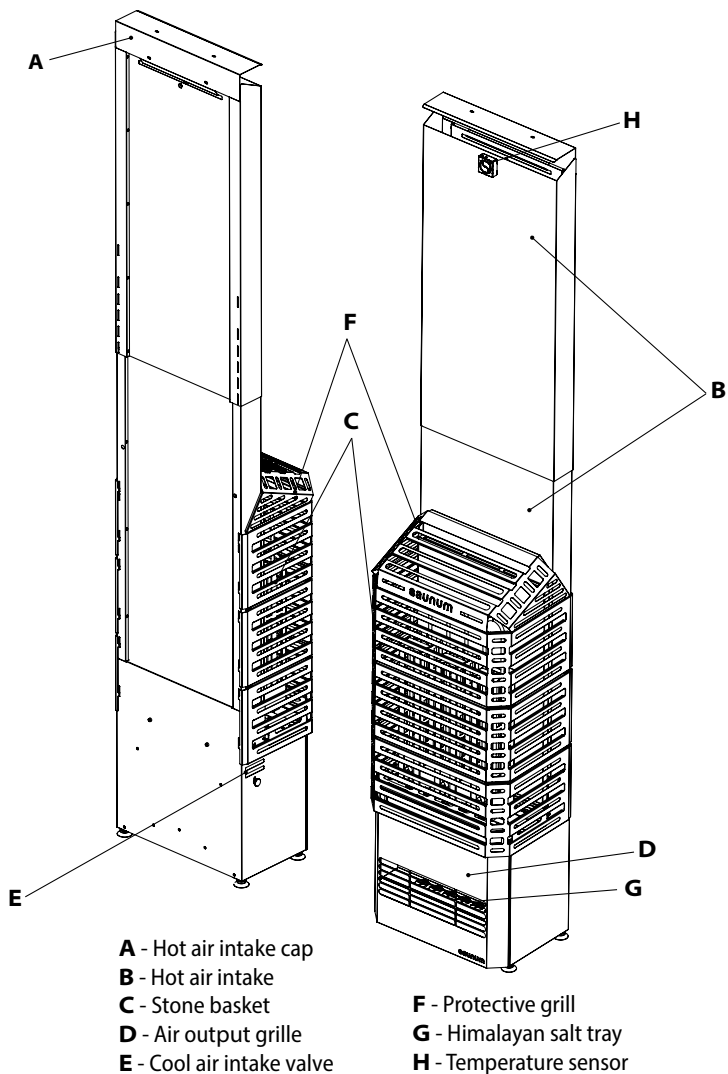

- A - Hot air intake cap
- B - Hot air intake
- C - Stone basket
- D - Air output grille
- E - Cool air intake valve

- F - Protective grill
- G - Himalayan salt tray
- H - Temperature sensor



Remove the protective film before assembling the heater!



1. Install the hot air intake cap (A) and center the heater housing in relation to the cap (B).

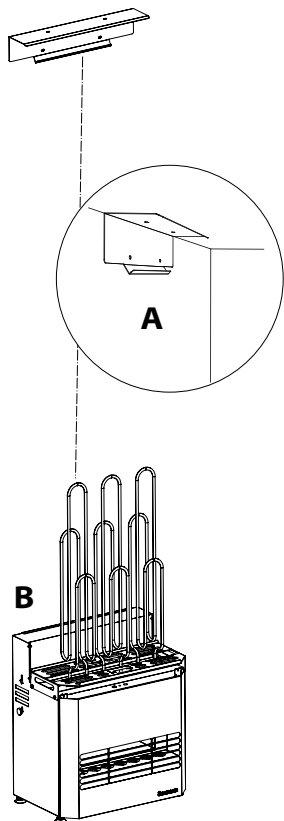

Place the cap at the connection point between the wall and the ceiling and fasten with a mounting suitable for the base material. It can be attached to the wall and/or the ceiling. Center the heater under the cap and adjust the feet so that the device is level.

2. Place the parts of the hot air intake inside each other. Next, place the lower part of the intake at the end of the heater's intake socket and adjust the feet of the heater; check the intake and the housing to make sure the device is level. Adjust the heater housing as needed.

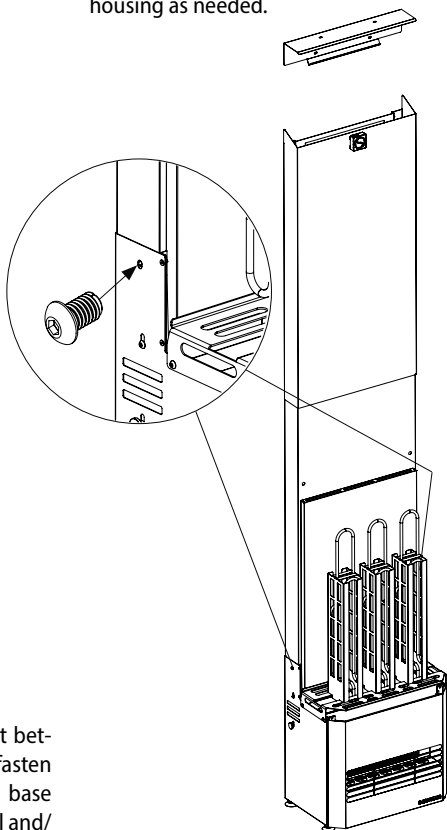

Carefully lower the intake inside each other into the intake socket on the top of the heater.

INSTALLATION INSTRUCTIONS



3. Hang the telescopic intake on the intake cap (A). Install the heat shield (B). Install the heat deflector (C).
4. Fasten the intake to the wall with screws.

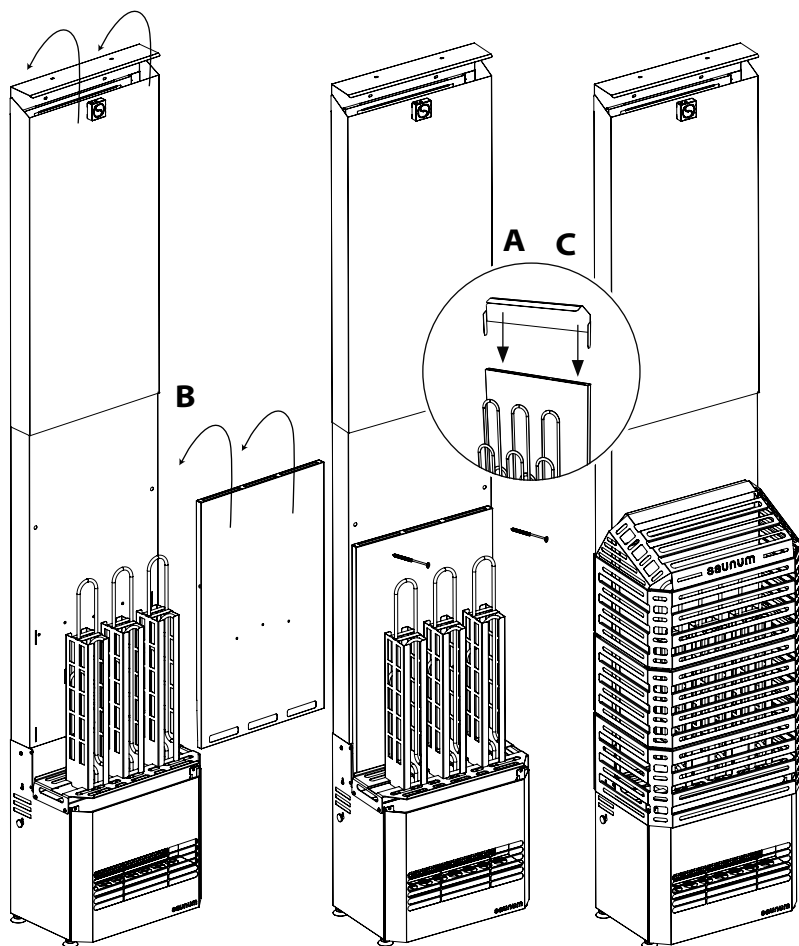



5. Install each stone basket section using the hooks in the opening behind the hot air intake. Fill the basket evenly with stones, wearing gloves to protect your hands. When the basket is correctly filled, install the next basket section and fill it (see **LOADING THE STONES** on page 12).

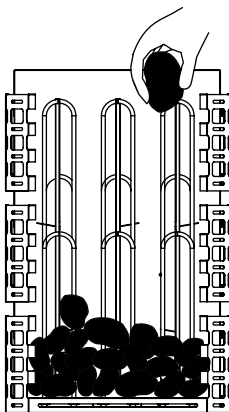
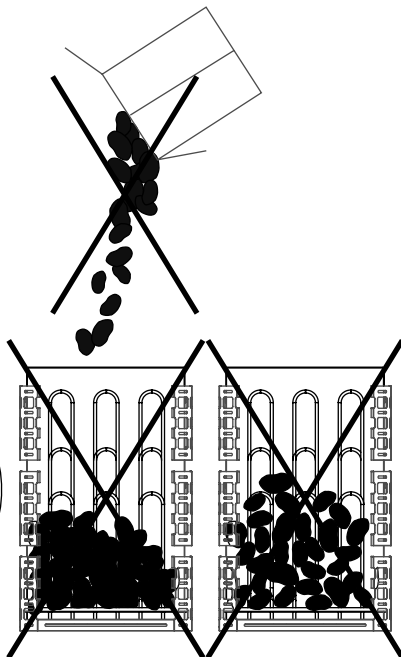
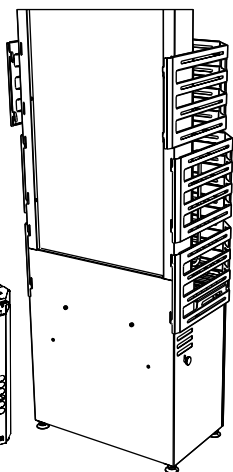
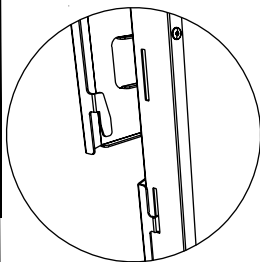
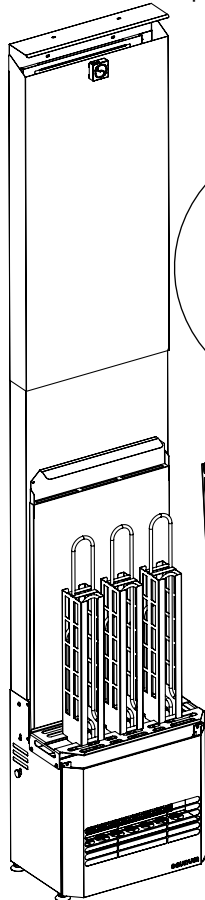



6. Install the salt.

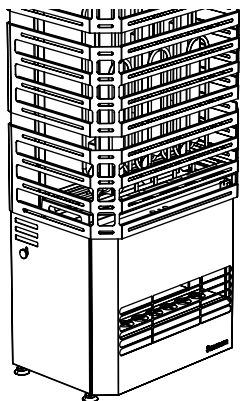

Remove the output grille by holding it slightly tilted and pulling it downwards.

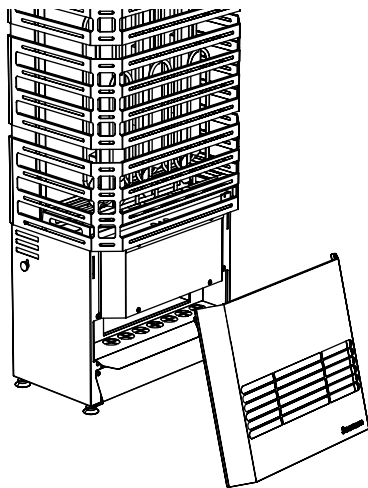

Place the salt in the sockets. To simplify the operation, the salt tray can be removed.

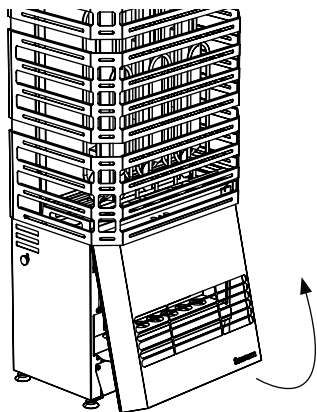

Pull from under the output grille edge outwards.

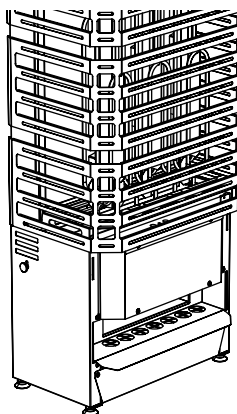



ELECTRICAL CONNECTIONS

7. Connect the Saunum Air to the IQ Air control unit.

The electrical connection of the device must be performed by a qualified person in accordance with the applicable standards and requirements.

The Saunum Air must be connected in a half stationary position to the junction box on the wall of the sauna room. The junction box must be splashproof and its maximum height from the floor can be up to 20 in. The power cable of the heater must meet the requirements of UL 62 in US and CSA 49 in Canada. To access the device electrical connections, it is necessary to open the bottom panel. To open the panel, completely loosen the two bolts under the device (see figure below).

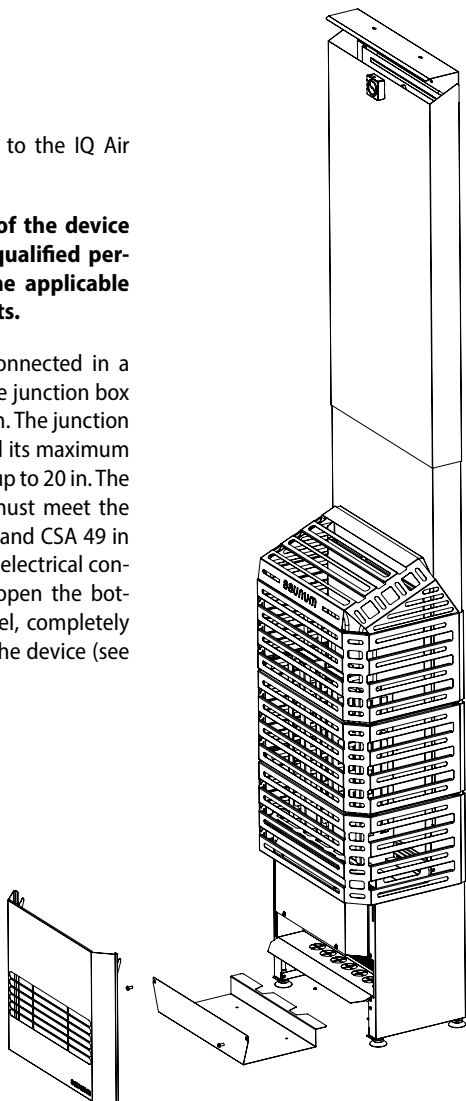

ELECTRICAL CONNECTION

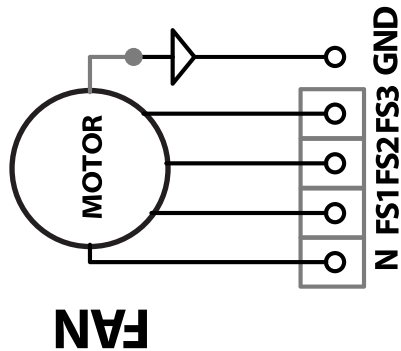

110-120 VAC FAN POWER SUPPLY TERMINAL

! CONNECTING IS PERMITTED ONLY THROUGH A SAFETY OR CONTROL DEVICE!

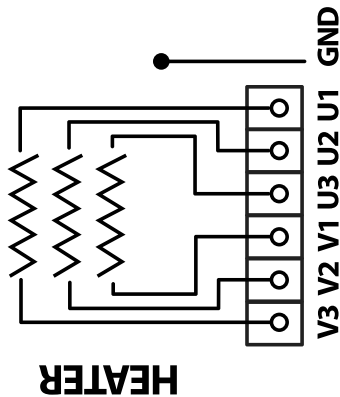

240 VAC HEATER POWER SUPPLY TERMINAL

! CONNECTING IS PERMITTED ONLY THROUGH A CONTROL DEVICE! DO NOT CONNECT THROUGH A GFCI BREAKER!





Due to the potential danger of thermal embrittlement, it is forbidden to use a PVC-insulated cable as the connection cable for the Saunum Air.

- The internal connections of the device are made by means of screw terminals according to Figure 3 (see page 29) and Table 1 (see pages 8–9) in this manual.
- Protective earthing (GND) must be connected to the connection terminal of the device, with the cross-sectional area of the cable being at least 14 AWG, 90°C/194°.
- The heater must be powered from the 240 VAC or 120 VAC 50/60 Hz supply circuit through a control device protected by an over-current fuse of the size shown in Table 1 (see pages 8–9).
- If you want to connect the air circulation fan of the device separately from the heater control device, the fan must be connected via a residual-current device. In this case, the protective earthing (GND) of the fan supply input terminal of the Saunum Air must not be brought into contact with the protective earthing of the heater supply input terminal. In this case, use earthed cables of at least 16 AWG, 194°F/90°C to power the fan.
- The power cable must enter the housing of the Saunum Air so that

the water does not flow along the cable into the electrical connection box of the housing of the Saunum Air. The outer insulation of the cable can only be peeled off only from the part that is in the device housing.

- If the connecting and installation cables are located higher than 40 in. from the floor of the sauna room or inside the walls of the sauna room, they must be able to withstand a temperature of at least 302 °F/150 °C (e.g., SSJ). Electrical equipment installed in the steam room below 40 in. must withstand a temperature of at least 194 °F/90 °C.
- The recommended cross-section of the connection cable grooves is given in Table 1 (see pages 8–9).



The Saunum Air may only be connected by a professional electrician in accordance with the applicable regulations!

ELECTRICAL CONNECTION

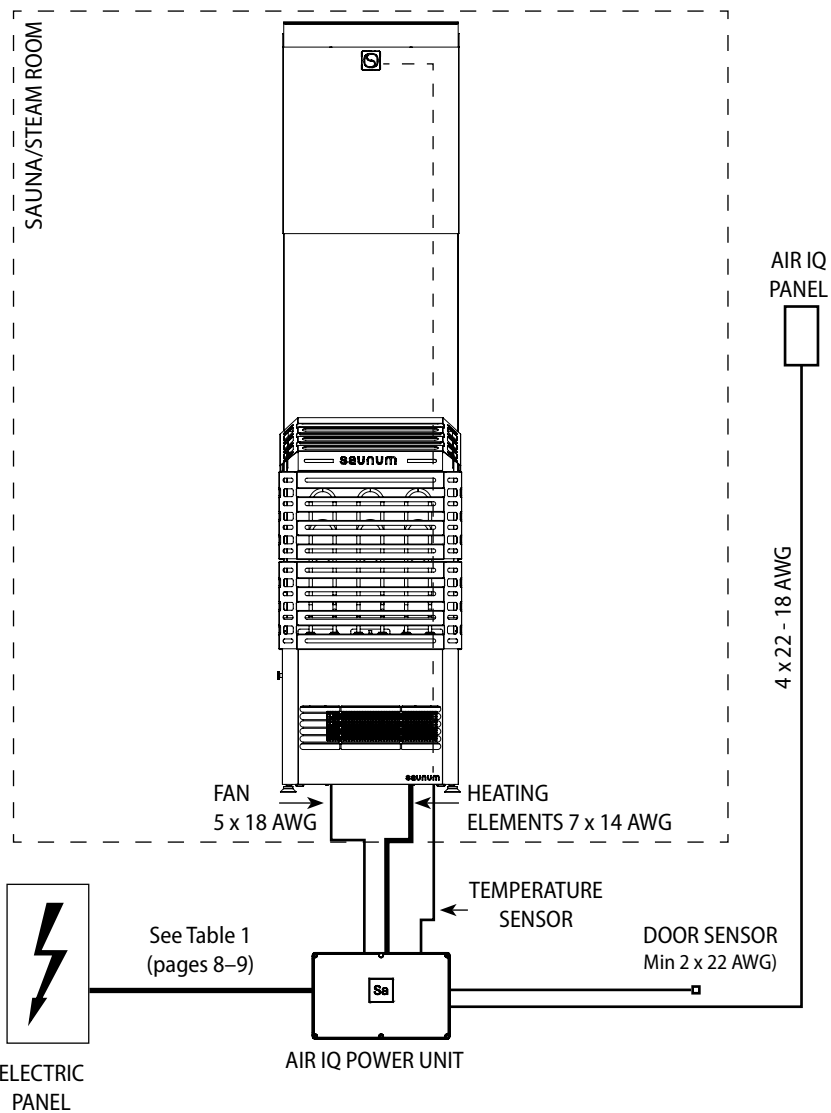



1. Remove the tape from temperature sensor cable that is fixed to the back of the hot air intake.

2. Unroll the temperature sensor on the backside of the air intake and find the entrance for cables at the bottom of the device.

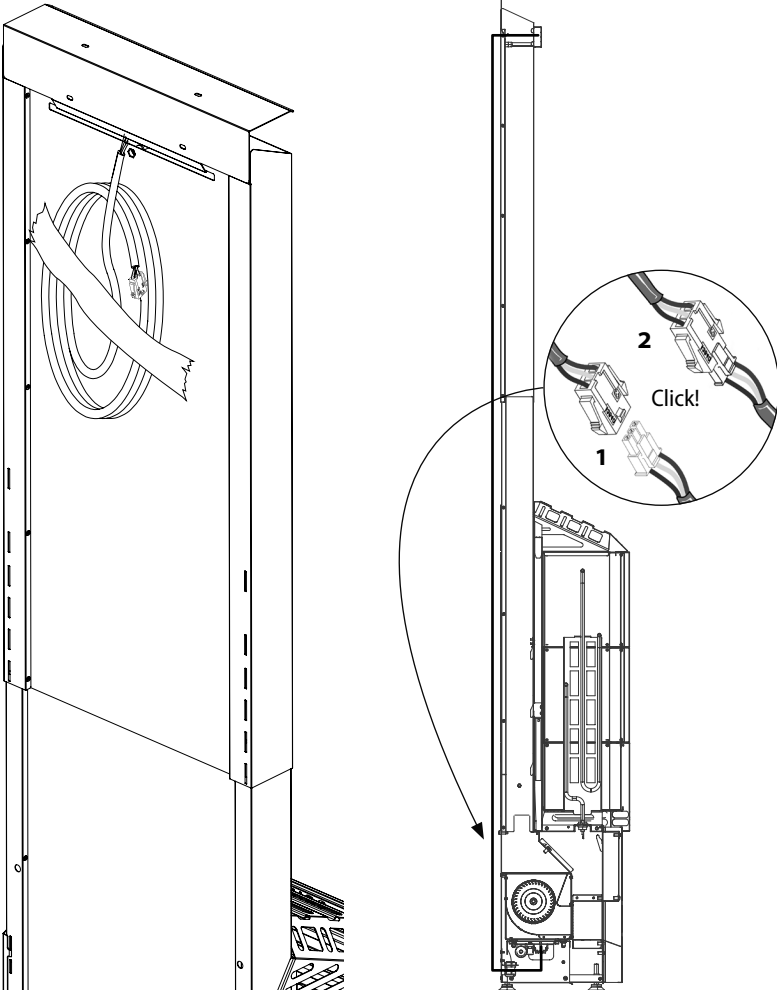

ELECTRICAL CONNECTION



3. Connect the temperature sensor cable in to terminal from the sensor side on the terminal 2.

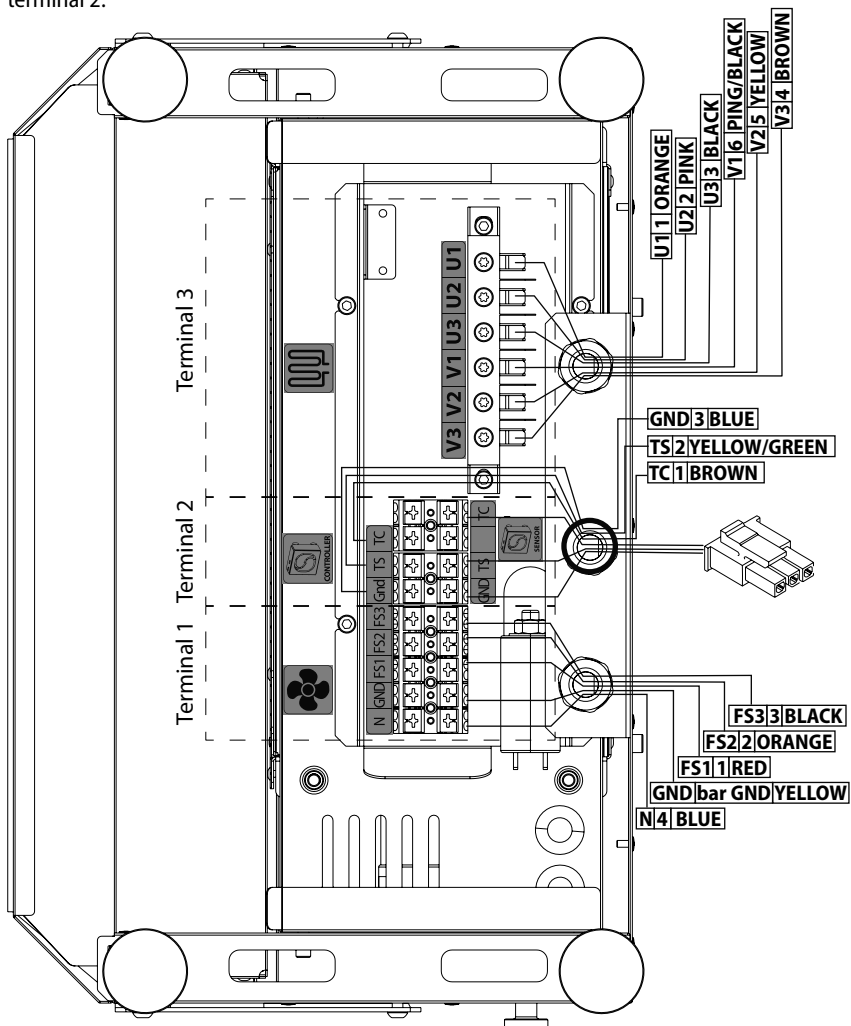



ELECTRIC HEATER INSULATION RESISTANCE

During the final inspection of the electrical installation, a leakage may be detected when measuring the insulation resistance of the Saunum Air, and which has occurred due to the insulation material of the heating elements absorbing moisture from the air (storage, transport). After a few uses of the Saunum Air, this moisture will disappear.



Do not connect the heater to the power and/or utilities via a GFCI breaker!

INSTALLING AND REPLACING THE HEATING ELEMENTS

The heating elements are connected to the device via screw terminals. It is necessary to disconnect the screw terminals before removing the heating elements.

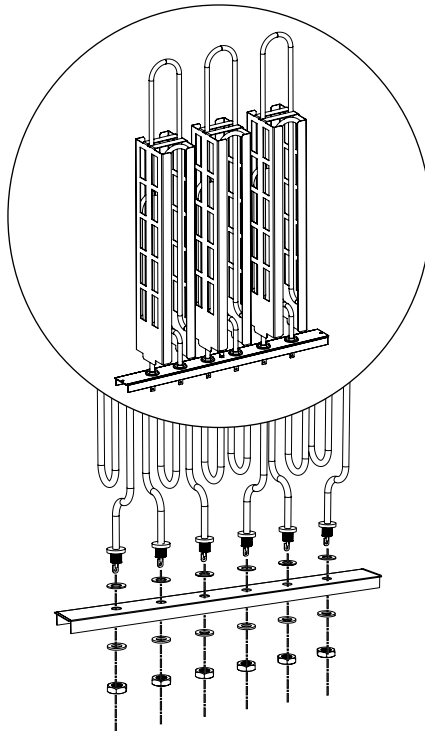



WARRANTY

With the Saunum device warranty, Saunum guarantees that the product will be free from defects in the materials and the assembly for a specified period after the date of purchase. If, during the warranty period, the device is found to be defective due to the use of substandard materials or the quality of the assembly, Saunum's recommended repair partners will repair or replace the device or its defective part without charge for labour and parts under the conditions set out below. Saunum reserves the right to decide whether to replace the defective product component or to replace the device with a new one. The replaced defective product components remain the property of Saunum.

Warranty conditions:

1. The warranty is only valid if a completed installation report is submitted with the claim.
2. The device has been connected to the power network by a qualified electrician in accordance with the regulations in force.
3. The warranty period of the sauna climate device when used in a private sauna is two (2) years.
4. The warranty period of the sauna climate device when used in a public sauna is one (1) year.

Not covered by the warranty:

1. Routine maintenance and cleaning of the device and replacement of the components due to normal wear and tear;
2. Adaptation or modification of the device for any purpose other than that indicated in the instructions for use;
3. Risks arising from transport;
4. Damage resulting from the misuse of the device;
5. Damage resulting from the improper installation of the device;
6. Repairs to the device not carried out by Saunum's recommended repair partner (maintenance partner);
7. Accidents, lightning, water, fire, improper ventilation, or any other factor beyond the control of Saunum;
8. Breakages caused by the use of stones and salt orbs not recommended by Saunum;
9. The heating elements and the salt.

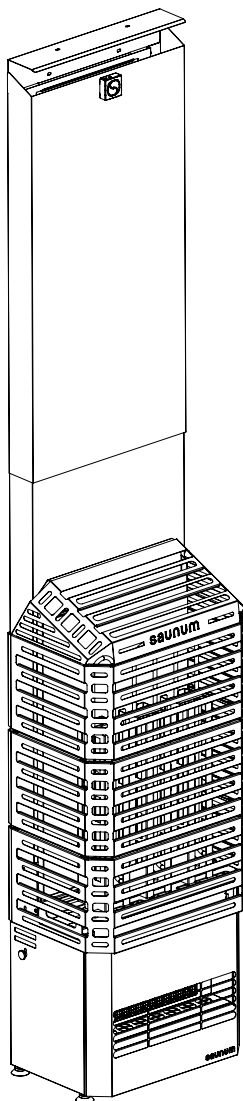

You can find the list of Saunum Saunas recommended installation and maintenance professionals on the Saunum Saunas website www.saunum.com

Saunum's device maintenance instructions can be found in the instructions for use.

Please note! The sauna may only be connected to the power network by a qualified electrician in accordance with the regulations in force.

Read all of the instructions for use carefully and thoroughly **before using the device** and keep them in a safe and easily accessible place for future reference.

WARRANTY



INSTALLATION REPORT

Date of purchase: _____

Heater type: _____

Sticker/serial number:

Date of installation: _____

Place of installation: _____

Installed by: _____

Checked by: _____

Date, signature: _____

Description of the work done: _____

All the details are available for the installation _____

There are no color defects or dents _____

Installed on the wall or on the floor according to the instructions _____

The electrical connections are made according to the installation instructions _____

All the heating elements heat up _____

The three fan speeds are working / in the correct order _____

Notes: _____

Customer's contact (name, email address): _____

Received work: _____

Warranty start date: _____



Sauna Heater
E525245

Manufacturer: Saunum Saunas North America LTD
Telliskivi Tn 60-1,
Põhja-Tallinna Linnaosa, 10412
Estonia

declares that the product:

Saunum Air

complies with the requirements of the following standards:

UL 875, Electric Dry-Bath Heaters, Edition 9, Revision Date 01/04/2021;
CSA C22.2 No. 164, Electric Sauna Heating Equipment, Edition 2,
Issue Date 02/2018.

These products do not contain hazardous substances in excess of 0.1% (SVHC) and meet the requirements of the REACH Regulation (1907/2006/EU REACH XVII) and comply with the requirements of the RoHS Directive (2011/65/EU, RoHS2 and 2015/863/EU, RoHS3)